

siegling
belting

TEXTILES – NONWOVEN





PRODUCTIVE DOWN TO THE LAST FIBRE: SIEGLING BELTING FOR THE NONWOVEN AND CLOTHING INDUSTRY

When top quality is a must, cost is a major factor and lost output is gauged in minutes, Forbo Siegling's products and services are the ideal choice.

Sophisticated, reliable and good value belting products will help you tap into your production machinery's potential and minimise downtimes. A range of extra products, such as splicing equipment, makes handling easier and increases the application's efficiency. More than 300 service points world wide ensure swift availability of spare parts and services around the clock.

From support, to fitting, to after-sales service, Forbo Siegling provides an **extensive range of services**. Our expert and experienced engineers are always at hand, from the moment you first talk to them right up to when the products are used.

Our experience tells us what services our customers need to increase their machinery's efficiency and ensure reliable production processes. With a customised service package, we can help you be one step ahead of the competition.

Just contact us.

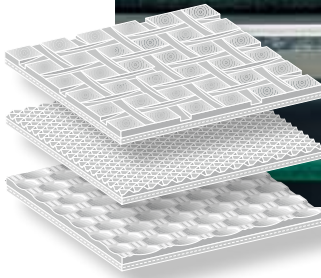

siegling transilon conveyor and processing belts

Siegling Transilon are fabric and nonwoven based conveyor and processing belts featuring a product range that covers both standard conveying and the most demanding and precise applications.

The fabric design and coating customise the mechanical, chemical and electrostatic characteristics of each belt type. We can offer you the right type of belt for all types of fabric conveying and other stages in nonwoven manufacture.

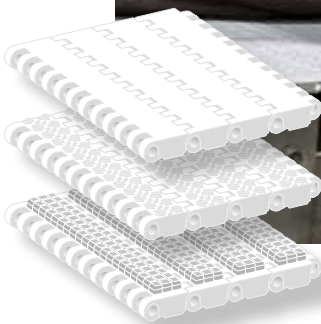

siegling prolink modular belts

Siegling Prolink are very robust and durable plastic modular belts.

Due to their form-fit design across the whole width and their very robust structure, they are equally ideal as feeder and discharge belts. Various top-face patterns turn them into specialists for the application concerned.

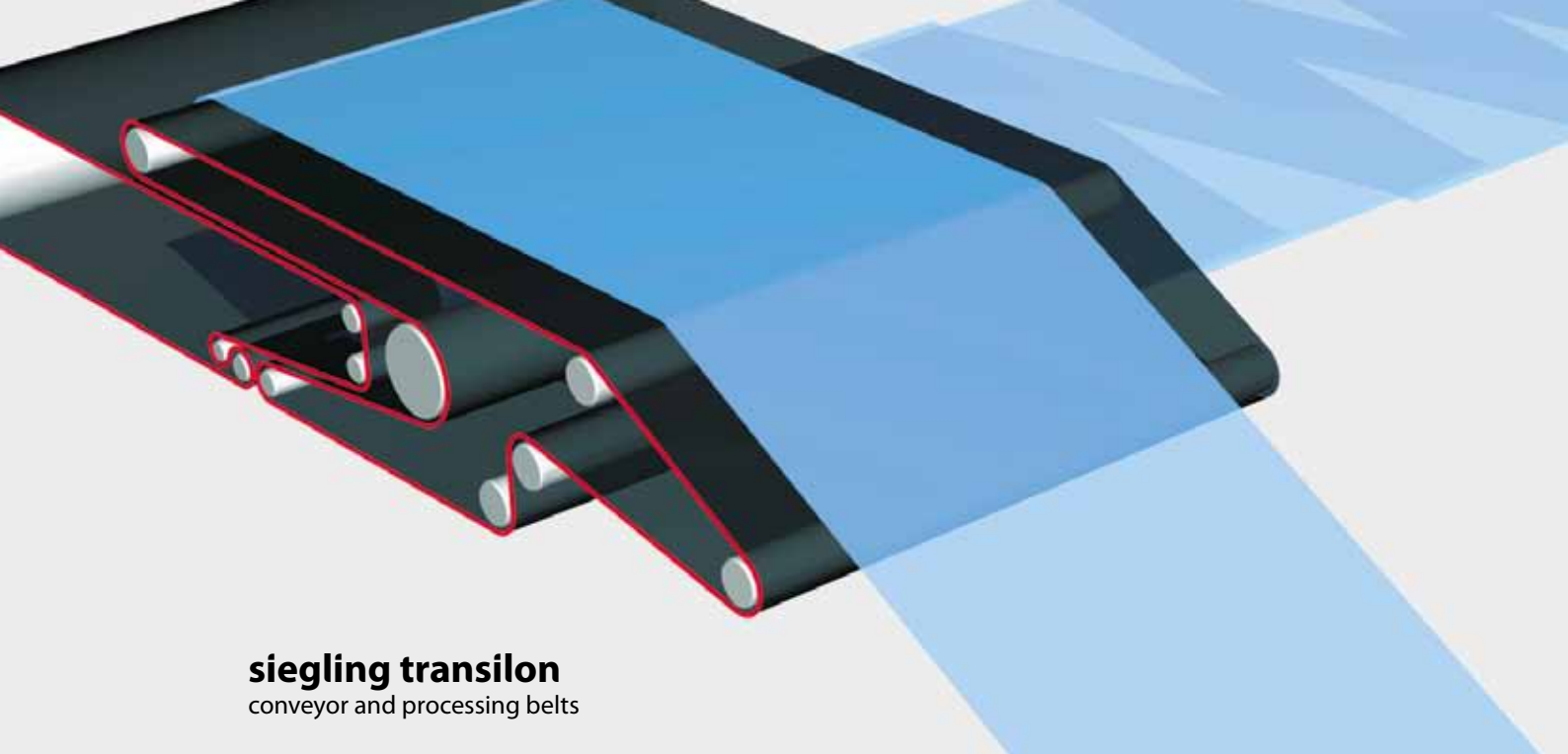

siegling transilon
conveyor and processing belts

WEB-LAYING BELTS IN THE CROSS-LAPPER SPEED AND PRECISION GO HAND IN HAND

The technical demands placed on web-laying belts are rising steadily in the face of ever faster machine speeds and the use of finer and more demanding synthetic nonwoven fibres and reduced web weights.

Forbo Movement Systems provides specially designed belt types for different fibres and nonwovens, with polyamide coating or especially low-friction urethane coating.

The properties

Polyamide coating:

lightweight belts	▶	makes for a high-speed process
very laterally stiff belt design	▶	very good flatness and running characteristics
good chemical resistance	▶	especially suitable for geotextiles
good grip	▶	very good for web conveying

Low-friction (LF) urethane coating:

excellent release properties, low-drag surface	▶	especially well-suited for ultrafine fibres
highly conductive Plus (HC+), Consistently conductive	▶	no malfunctions due to electrostatic build-up

The advantages

E 4/2 U0/P2 MT-HC grey/black (906840)

- exceptionally robust and chemically resistant (finish)
- for general applications on high-speed systems and as replacement belts on existing machines
- highly conductive polyamide coating on one side
- with 2-ply tension member consisting of laterally stiff polyester fabric

Production width 3000 mm, 3500 mm, 4100 mm on request

Total thickness approx. 0.9 mm

Weight approx. 0.8 kg/m²

Splice Z or wedge-overlap, plastic fasteners (KS), wedge splice

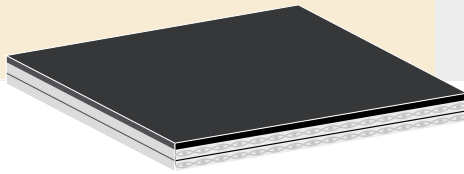

E 4/2 U0/U2 LF-HC+ black (906553)

- exceptionally low drag
- for use on high-speed systems and for processing ultrafine fibres
- highly conductive, LF urethane coating on one side
- with 2-ply tension member consisting of laterally stiff polyester fabric

Production width 3100 mm, 3650 mm, 4100 mm on request

Total thickness approx. 1.0 mm

Weight approx. 1.1 kg/m²

Splice Z-splice, plastic fasteners (KS)

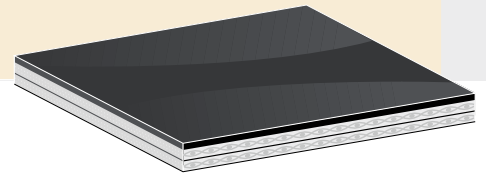

CONVEYOR BELTS IN CUTTING SYSTEMS CUTTING TO SIZE EFFICIENTLY

In automatic cutting machines, NOVO types are used. These belts are made of homogeneous polyester fibre bundle and are exceptional due to the following properties:

- low-noise
- flat surface with good grip for the gentle and reliable conveying of cloth
- exceptionally good cut resistance
- air-permeable (cloth is suctioned through the belt which holds it in place)

As a smooth base for manual cutting, our belt type E 8/2 U0/U2 LF green is used. Its extremely low-drag, low-friction (LF) surface has significant advantages over conventional belt surfaces:

- material can be moved and positioned on the surface very easily
- knife runner slides easily on the top face, reducing wear on the runner and belt as well as enabling precise cutting with little effort.



Product Range Siegling Transilon (Selection)

Article number	Total thickness approx. [mm]	Weight approx. [kg/m ²]	Effective pull at 1% elongation (k _{1%} relaxed) [N/mm width]*	d _{min} approx. [mm]	Machinery for unravelling and preparing fibres	Blenders and charging machines	Cards, web conveying in general	Cross-lappers	Needle machines	Coating and drying machines	Cloth-spreading and strip-cutting machines	Laundry folders
Polyester types												
E 2/1 0/V/NOVO-NA-Q grey	906500	1.65	1.45	1.5	24							
NOVO 25-HC black	900195	2.5	1.3	7	40						●	●
NOVO 40-HC black	900221	4.0	2.2	7.5	90						●	
Urethane types												
E 3/1 U0/U2 HACCP white FDA	900006	1.15	1.2	3.5	r 3–8				●			
E 3/2 U0/U2 HACCP white FDA	900103	1.45	1.6	5.5	r 3–8	●			●	●		
E 4/2 U0/U2 LF-HC+ black	906553	1.0	1.0	3	60			●				
E 8/2 U0/U2 LF green	906450	1.45	1.6	6.5	40/24 (Z) ¹⁾		●				●	
PVC types												
E 8/2 U0/V2M MT white FDA	906799	1.5	1.65	6	40	●	●	●	●	●	●	●
E 8/2 U0/V5 green	900025	2.1	2.5	7.5	40/30 (Z) ¹⁾	●	●	●	●	●	●	●
E 8/2 U0/V5H MT black	900026	2.2	2.5	7.5	50/40 (Z) ¹⁾	●	●	●	●	●	●	●
E 8/2 U0/V5 NP white FDA	900029	2.1	2.15	6	40	●	●	●		●		
E 8/2 U0/V7 SG black	906286	2.3	2.45	6	40	●	●	●				●
E 8/2 U0/V10 SG green	900086	2.6	2.85	7	40	●	●	●				●
E 8/2 V5/V5 STR/GL green	900030	2.65	3.2	7	40	●	●	●		●		
E 12/2 U0/V7 green	900045	2.85	3.4	12	60		●	●			●	
E 12/2 U0/V20 green	900262	3.35	4.1	11	60		●	●			●	
Polyamide types												
E 4/2 U0/P2 MT-HC grey/black	906840	0.9	0.8	4	50			●	●			
E 4/1 P2/P2 MT/MT-HC black ²⁾	906396	0.75	0.8	3.5	80			●	●			

Please note: the values stated are nominal and can fluctuate in a belt whose width is a result of production processes. Our products are constantly adapted to market requirements. Consequently, changes in technical parameters can occasionally occur. Therefore, please see the current product data sheets for specific information on designs and calculations.

Abbreviations

* Established in line with ISO 21181:2005

¹⁾ (Z) = only with Z-splice

²⁾ B_{max} = 3000 mm

GL	= Smooth surface
MT	= Matt surface
NP	= Inverted pyramid pattern
SG	= Lattice pattern
STR	= Normal textured pattern
FDA	= FDA-compliant
HACCP	= Supports the HACCP concepts
HC	= Highly-conductive
HC+	= Highly-conductive plus
LF	= Low friction
Q	= Laterally soft tension member, not for curved belts

Profiles/patterns

① For machinery without belt-tracking systems with short centre distances, longitudinal tracking profiles are often used. Profiles made of PVC, urethane or polyester are available.



Available as

- endless belts
- belts prepared for hot or cold-pressing on site
- roll material for independent belt fabrication
- belts with mechanical fasteners
- belts with sealed edges (Proseal)
- belts with profiles welded on

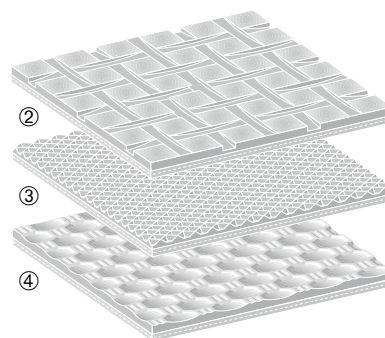

- ② Lattice pattern (SG)
- ③ Inverted pyramid pattern (NP)
- ④ Normal textured surface (STR)

Splice technology

Z splices, Z-stepped overlap splices, overlap splices or hook splices are used depending on the application. The belts are easy, quick and reliable to splice on site.

An innovative very lightweight series of presses makes direct fitting on the conveyor easier (for belt widths up to 4000 mm).

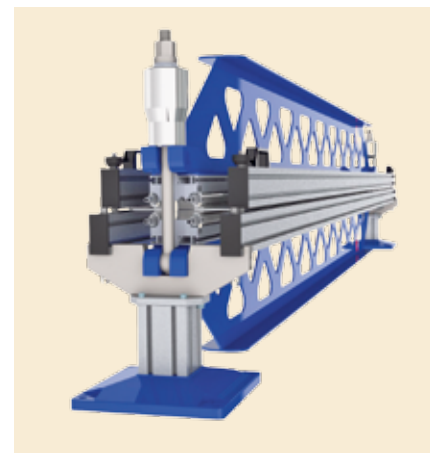

siegling prolink
modular belts

PLASTIC MODULAR BELTING FOR NONWOVEN CONVEYING AN UPGRADE FOR **RELIABLE AND EFFICIENT PRODUCTION**

Where fabric belts and lattice conveyors work well, Siegling Prolink modular belts are often superior: in production lines, as a substitute for lattice conveyors, in infeed and mixing lines. They deliver tangible advantages in the conveyance of fibre materials and nonwovens at all processing stages.

- enhanced durability and longer service life due to our robust design features
- reliable belt tracking utilizing sprocket-driven operation
- overall cost savings and easy installation

Siegling Prolink can be easily integrated into existing machinery:

- replacing existing drive roll with square shaft for sprocket-driven belting
- lagging of existing rollers (optimal for floor aprons); decreases conversion costs and is simple and fast
- new continuous NSK2 pattern (non-skid) with an enhanced semi-circular design prevents fibers from sticking

Profiles/patterns

- ① **S8-0 FLT PP:** Closed, smooth surface
- ② **S8-0 NSK2 PP:** Closed surface with non-skid pattern
- ③ **S8-0 FRT1 PP:** Closed surface with friction top where extremely strong grip is required

Prolink Series 8 (PP-Types)

For conveying fibres and nonwovens

Belt width	variable in increments of 12.7 mm
Total thickness	10.5 mm (without profile)
Weight	7.1 to 12.6 kg/m ² (depending on the profile type)
Hinge pins	ø 5 mm, made of PP (Polypropylene)



Siegling – total belting solutions

Committed staff, quality oriented organization and production processes ensure the constantly high standards of our products and services. The Forbo Siegling Quality Management System is certified in accordance with ISO 9001.

In addition to product quality, environmental protection is an important corporate goal. Early on we also introduced an environmental management system, certified in accordance with ISO 14001.



Ref. no. 295-2
07/14-UDH: Reproduction of text or parts thereof only with our approval. Subject to change.



Forbo Siegling service – anytime, anywhere

The Forbo Siegling Group employs more than 2,500 people. Our products are manufactured in ten production facilities across the world. You can find companies and agencies with warehouses and workshops in over 80 countries. Forbo Siegling service points are located in more than 300 places worldwide.

Forbo Siegling GmbH

Lilienthalstrasse 6/8, D-30179 Hannover
Phone +49 511 6704 0
www.forbo-siegling.com, siegling@forbo.com



MOVEMENT SYSTEMS